

Data Sheet

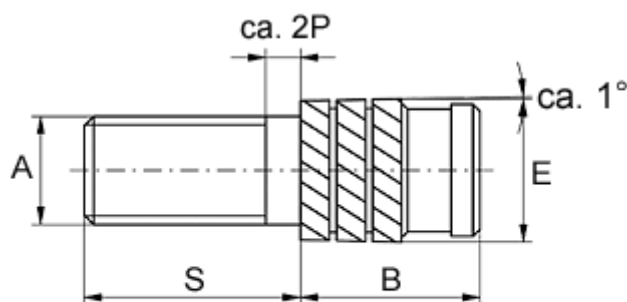

Article number: 12856000020820
Description: KLEE-coil 856 000 020.820
M2 Brass

Measures



Gevindlængde = $S - 2P$
P = stigning

Male thread A	= M2x0,4
Min distance to edge	= 1.6
Mounting length B	= 4.0
Outer diameter E	= 3.35
Pin length S	= 6
Recommended bore diameter	= 3.1
Type	= 856 000 020.820